

# Torneo Junior Villa Aviles 2016

Aviles (AST), 22 Oct 2016

## -60 kg

32 Judoka

POOL A

1	ALEXANDRE, Carlos	POR	1
17	ORTS BUITRAGO, Javier	VAL	17
9	SANTIBANEZ LARA, Gonzalo	MAD	2
25	AUTON FERNANDEZ, Javier	GAL	25
5	LOPEZ MOTA, Javier	CLE	3
21	LARA PINERA, Alvaro	AST	18
13	LAM RUBIERA, Diego	GAL	4
29	PEREIRO VELASCO, Eneko	VAS	4

POOL B

3	LOSADA VALLE, Ivan	GAL	5
19	CRUZ, Felipe	POR	19
11	SAIZ JUAN, Ian	MAD	6
27	GONZALEZ MARTIN, Victor	CLE	26
7	CAMARGO BELMAR, Adrian	MAD	7
23	GONZALEZ CASTRILLO, Eliecer	CLE	20
15	NAVARRO MUNOZ, Juan	GAL	8
31	CADENAS FERNANDEZ, Jesus	AST	8

POOL C

2	MUNOZ ALLUE, Jaime	ARA	9
18	RAD, Javier	AST	21
10	RIPEBRE FERNANDEZ, Jose	GAL	10
26	RAMOS VARA, Jose	CLE	27
6	SANTIAGO PASTOR, Jose Alberto	MAD	11
22	PORTILLO CEREZO, Imanol	VAS	22
14	COSTA, Jose	POR	12
30	GARCIA PINTO, Sergio	CLM	12

POOL D

4	BARBERO BASCONES, David	CLE	13
20	GARCIA CACHAFEIRO, Diego	MAD	23
12	FREITAS, Gonzalo	POR	14
28	UZAL BUSTO, Adrian	GAL	28
8	RODRIGUEZ DIAZ, Cristian	GAL	15
24	BULDAIN ELIZALDE, Iban	NAV	24
16	ANTON ZURDO, Carlos	CLE	16
32	GONZALEZ TORANO, Daniel	AST	16

Trostrunde / Repechage / Ronda de consolación

Repechage / Trostrunde / Repecha



1.

43

POOL C Winner / Ganador  
Vainqueur / Sieger

POOL D Winner / Ganador  
Vainqueur / Sieger

Results

Résultat / Platzierungen / Resultados

- 1.
- 2.
- 3.
- 3.
- 5.
- 7.
- 7.

3.

3.

# Torneo Junior Villa Aviles 2016

Aviles (AST), 22 Oct 2016

## -66 kg

28 Judoka

POOL A

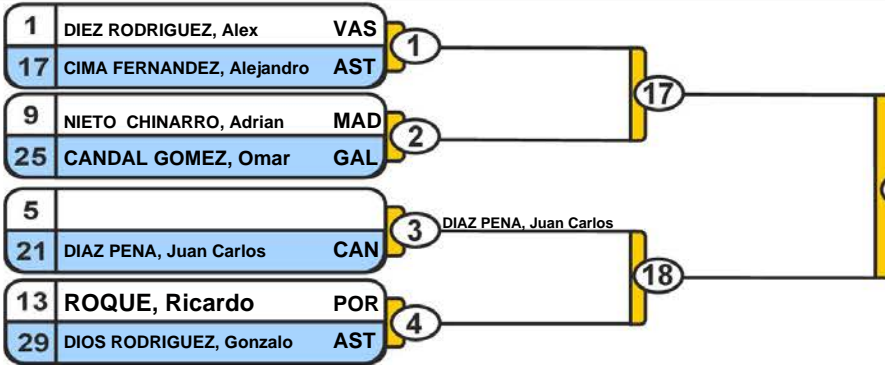

POOL A Winner / Ganador  
Vainqueur / Sieger

POOL B

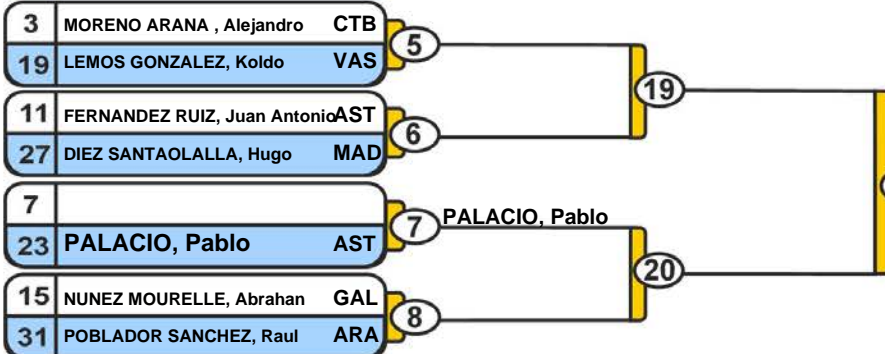

POOL B Winner / Ganador  
Vainqueur / Sieger

POOL C

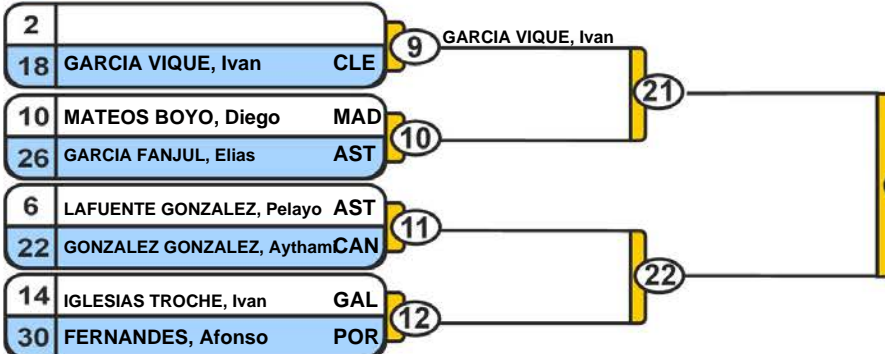

POOL C Winner / Ganador  
Vainqueur / Sieger

POOL D

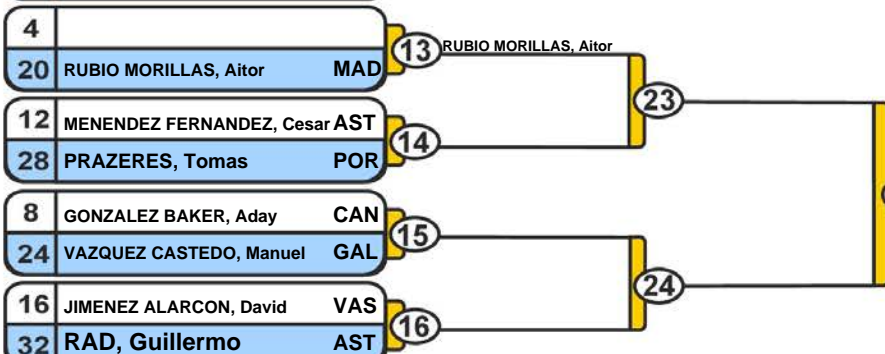

POOL D Winner / Ganador  
Vainqueur / Sieger

1.

43

38

### Trostrunde / Repechage / Ronda de consolación

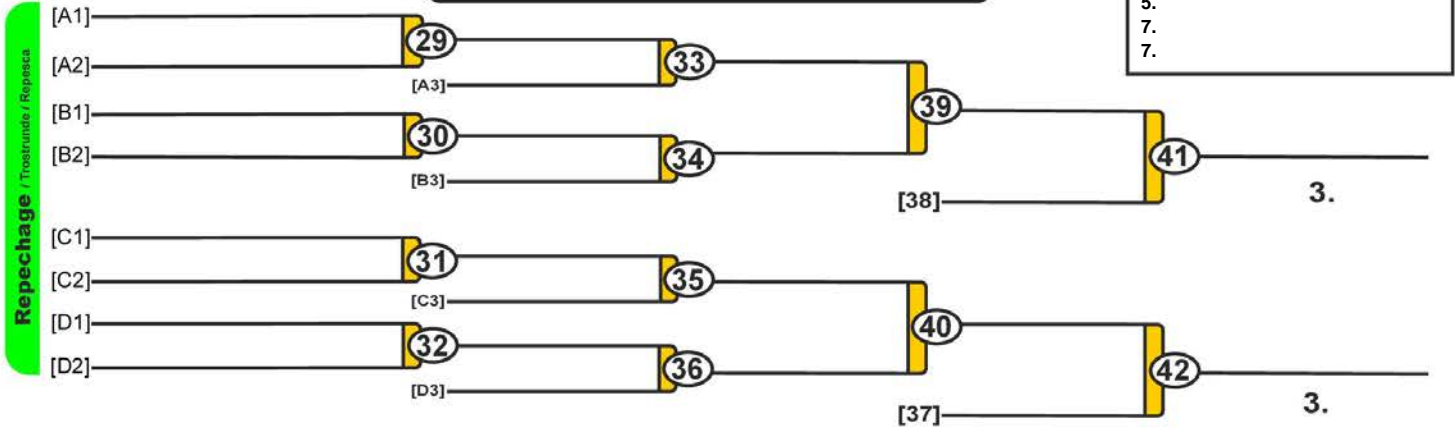

Results	
Résultat / Platzierungen / Resultados	
1.	
2.	
3.	
3.	
5.	
5.	
7.	
7.	

# Torneo Junior Villa Aviles 2016

Aviles (AST), 22 Oct 2016

## -73 kg

23 Judoka

POOL A

1	GRIGORE, Daniel	VAS
17	LARRALDE TRUJEDA, Cristian	CTB
9	TOMAS FERNANDEZ, Xulian	AST
25	GOMEZ DEL HIERRO, Ernesto	GAL

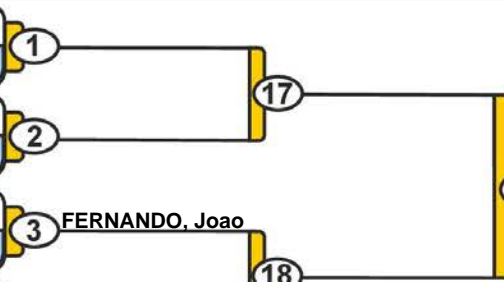

POOL A Winner / Ganador  
Vainqueur / Sieger

POOL B

3	URDANGARIN LARRANAGA, Har	VAS
19	CAMBON OLEA, Jorge	GAL
11	PEREZ ESPINAR, Ricardo	CLE
27		



POOL B Winner / Ganador  
Vainqueur / Sieger

POOL C

2		
18	MORALES BILBAO, Francisco	CTB
10	CARREIRA REDONDO, Jorge	GAL
26	NIETO PALMA, Andres	CLE

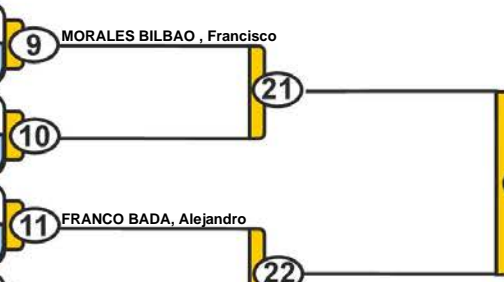

POOL C Winner / Ganador  
Vainqueur / Sieger

POOL D

4		
20	TERRAZAS PACHECO, Miguel Angel	CLE
12	CASTELAO CUETO, Pablo	AST
28		



POOL D Winner / Ganador  
Vainqueur / Sieger

Trostrunde / Repechage / Ronda de consolación

Repechage / Trostrunde / Ronda de consolación

[A1]	29	
[A2]		33
[B1]	30	
[B2]		34
[C1]	31	
[C2]		35
[D1]	32	
[D2]		36

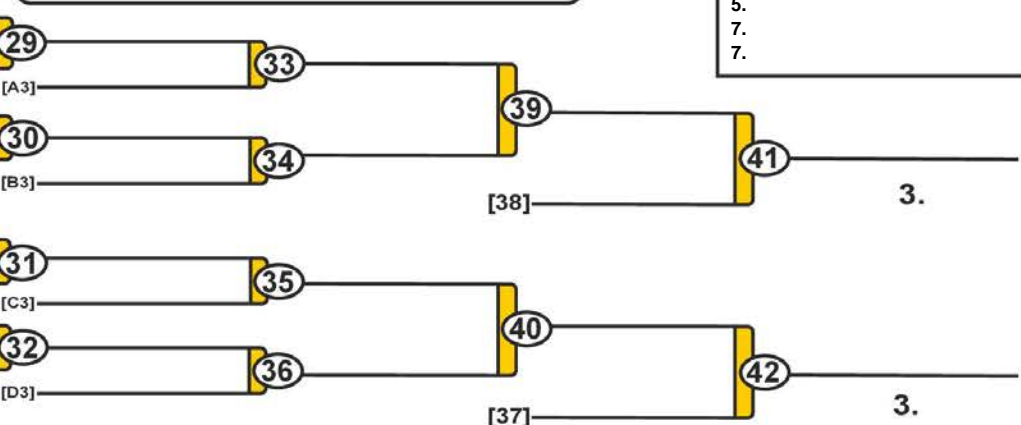

Results	
Résultat / Platzierungen / Resultados	
1.	
2.	
3.	
3.	
5.	
5.	
7.	
7.	

# Torneo Junior Villa Aviles 2016

Aviles (AST), 22 Oct 2016

## -81 kg

17 Judoka

POOL A

1	ERAZO ALEGRIA, Juan Manuel	CTB	1	ERAZO ALEGRIA, Juan Manuel
17			17	
9	IGLESIAS VAZQUEZ, David	GAL	2	IGLESIAS VAZQUEZ, David
25			25	
5	CANO LEITON, David	VAS	3	CANO LEITON, David
21			18	
13	HAMBARZUMYAN, Aharon	GAL	4	HAMBARZUMYAN, Aharon
29				

POOL A Winner / Ganador  
Vainqueur / Sieger

POOL B

3	PEREIRA AMORIN, Brais	GAL	5	PEREIRA AMORIN, Brais
19			19	
11	FERNANDEZ SANCHEZ, Ivan	EXT	6	FERNANDEZ SANCHEZ, Ivan
27				
7	ALONSO PASTRANA, Jorge	GAL	7	ALONSO PASTRANA, Jorge
23			20	
15	CORDOBA FERNANDEZ, Carlos	AST	8	CORDOBA FERNANDEZ, Carlos
31				

POOL B Winner / Ganador  
Vainqueur / Sieger

POOL C

2	SECEAC, Bogdan	ARA	9	SECEAC, Bogdan
18			21	
10	ISHKHANYAN, Arten	GAL	10	ISHKHANYAN, Arten
26				
6	QUEVEDO ROMERO, Alejandro	CAN	11	QUEVEDO ROMERO, Alejandro
22			22	
14	MARTINEZ FERNANDEZ, Samuel	GAL	12	MARTINEZ FERNANDEZ, Samuel
30				

POOL C Winner / Ganador  
Vainqueur / Sieger

POOL D

4	MADERA BARRIGA, Felipe Cruz	VAS	13	MADERA BARRIGA, Felipe Cruz
20			23	
12	SOIMOES, Renato	POR	14	SOIMOES, Renato
28				
8	VILA FREIRE, Diego	GAL	15	VILA FREIRE, Diego
24			24	
16	HUMADA TORRES, Eduardo	CLE	16	
32	GARCIA GANDARA, Alberto	GAL		

POOL D Winner / Ganador  
Vainqueur / Sieger

Trostrunde / Repechage / Ronda de consolación

Repechage / Trostrunde / Ronda de consolación

[A1]	29	[A2]	33	[A3]	
[B1]	30	[B2]	34	[B3]	
[C1]	31	[C2]	35	[C3]	
[D1]	32	[D2]	36	[D3]	
					39
					41
					42
					43
					44
					45
					46
					47
					48
					49
					50
					51
					52
					53
					54
					55
					56
					57
					58
					59
					60
					61
					62
					63
					64
					65
					66
					67
					68
					69
					70
					71
					72
					73
					74
					75
					76
					77
					78
					79
					80
					81
					82
					83
					84
					85
					86
					87
					88
					89
					90
					91
					92
					93
					94
					95
					96
					97
					98
					99
					100

Results

Resultat / Platzierungen / Resultados

- 1.
- 2.
- 3.
- 3.
- 5.
- 5.
- 7.
- 7.

# Torneo Junior Villa Aviles 2016

Aviles (AST), 22 Oct 2016

## +81 kg

16 Judoka

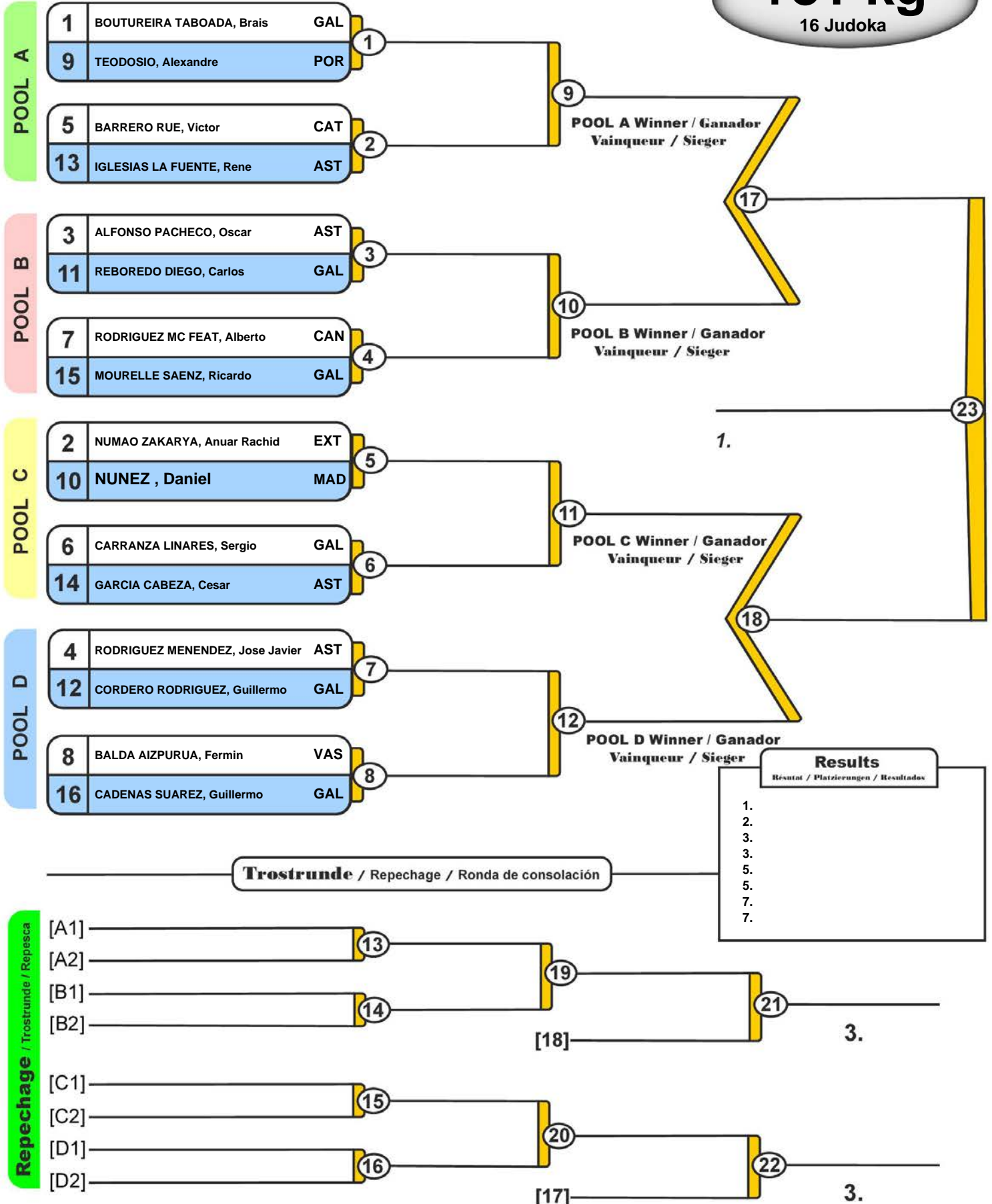

# Torneo Junior Villa Aviles 2016

Aviles (AST), 22 Oct 2016

## -48 kg

7 Judoka

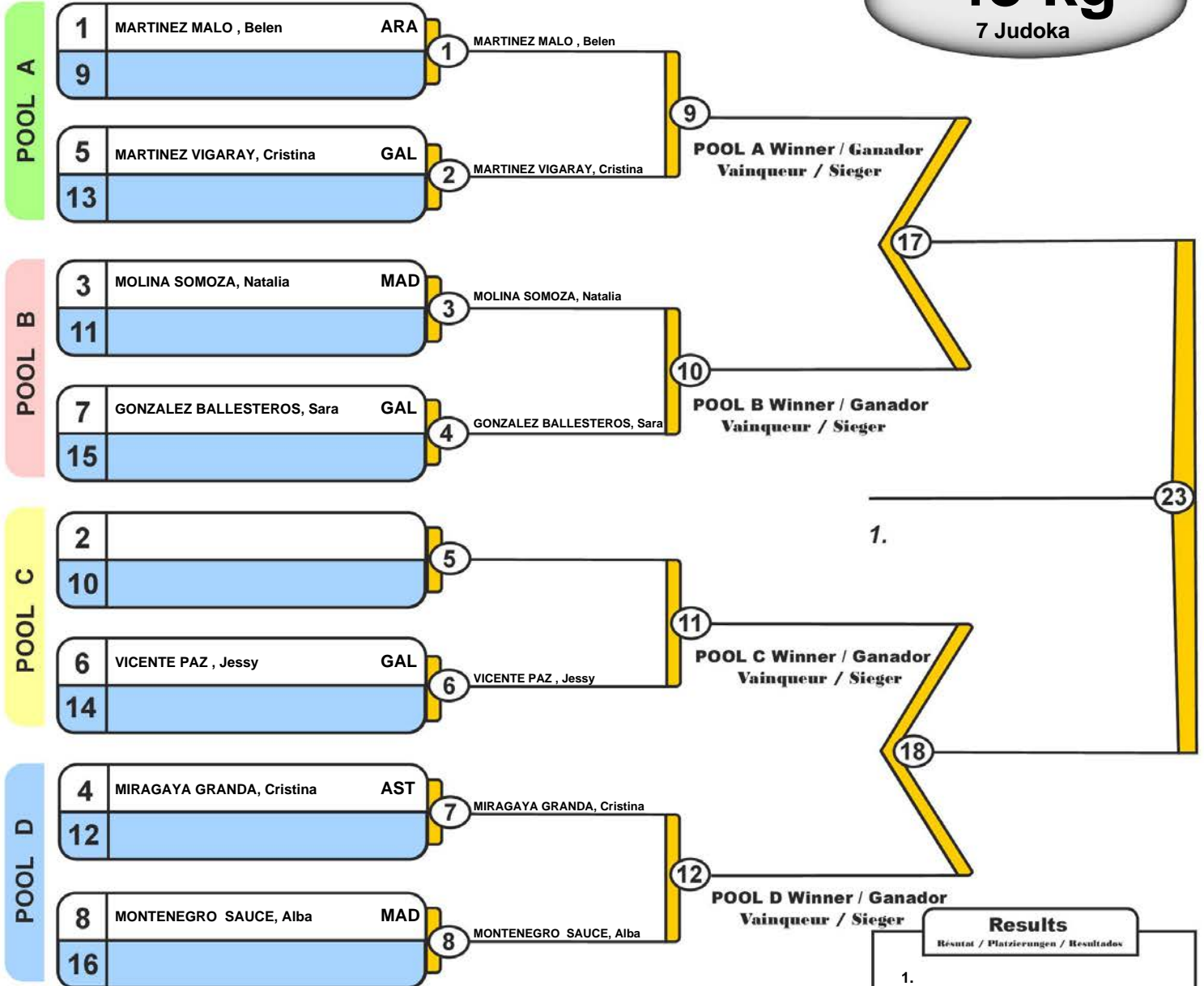

**Trostrunde / Repechage / Ronda de consolación**

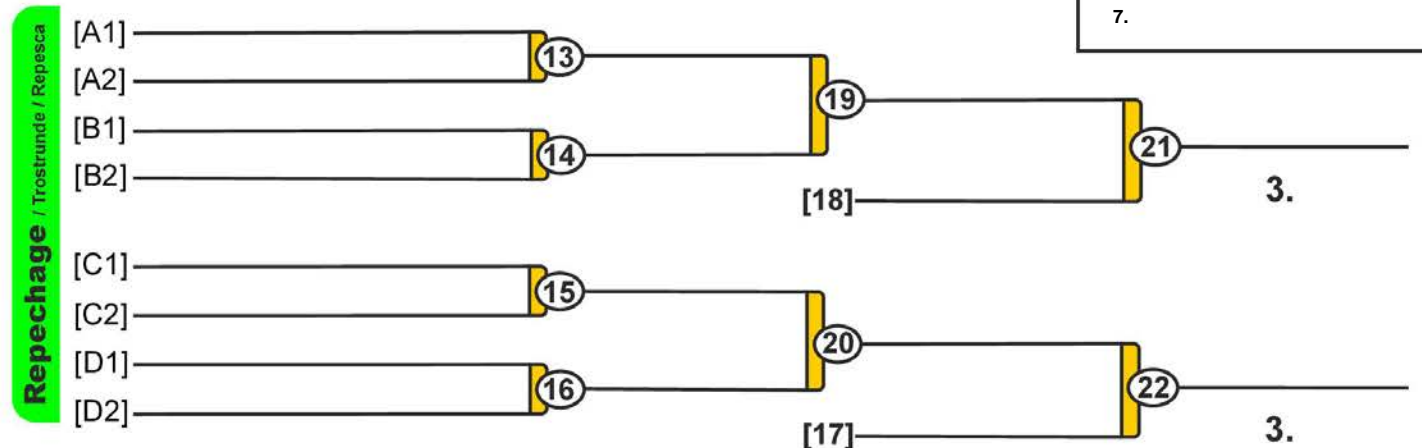

Results	
Resultat / Platzierungen / Resultados	
1.	
2.	
3.	
3.	
5.	
5.	
7.	
7.	

# Torneo Junior Villa Aviles 2016

Aviles (AST), 22 Oct 2016

## -52 kg

6 Judoka

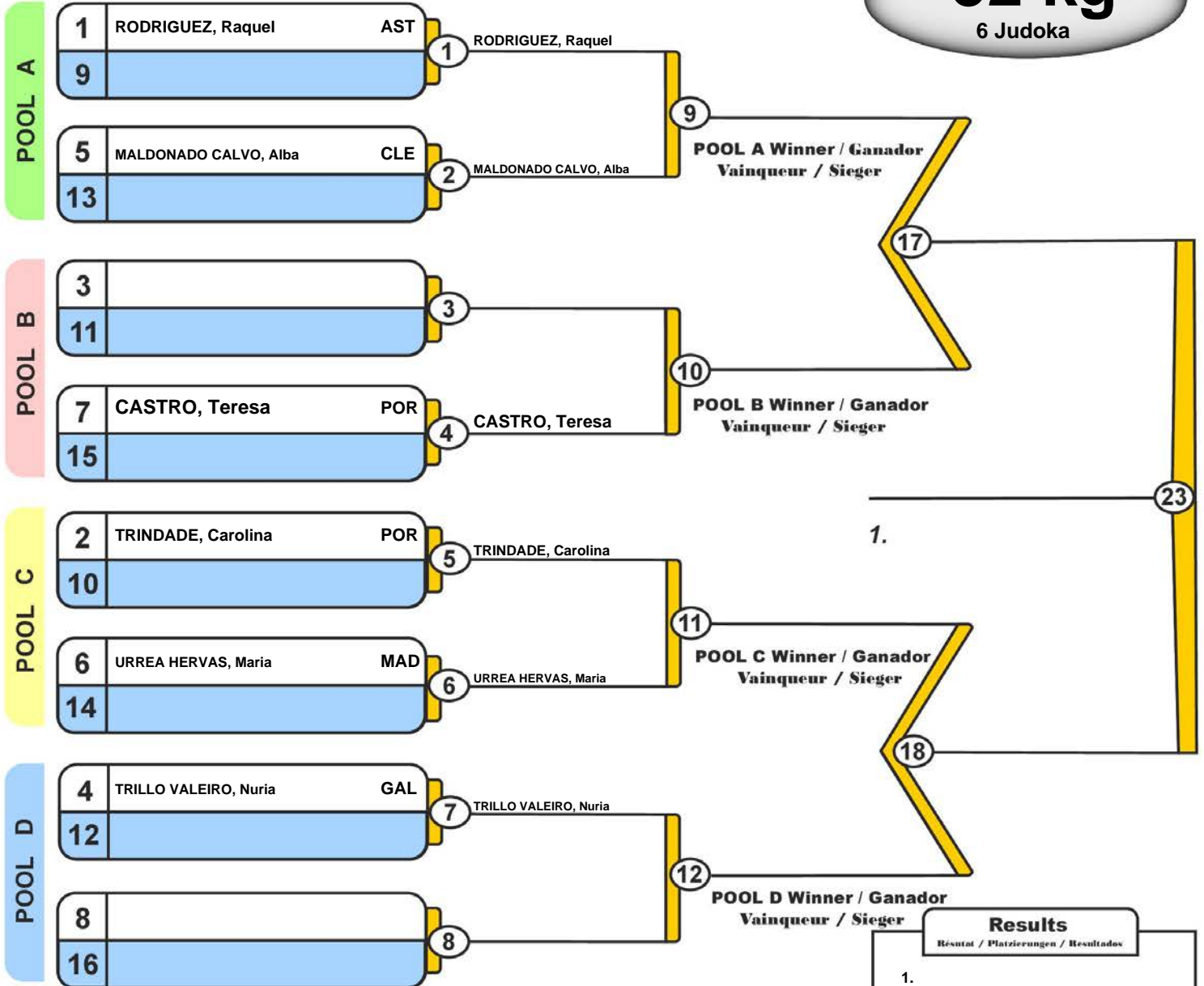

1.

18

Results	
Resultat / Platzierungen / Resultados	
1.	
2.	
3.	
3.	
5.	
5.	
7.	
7.	

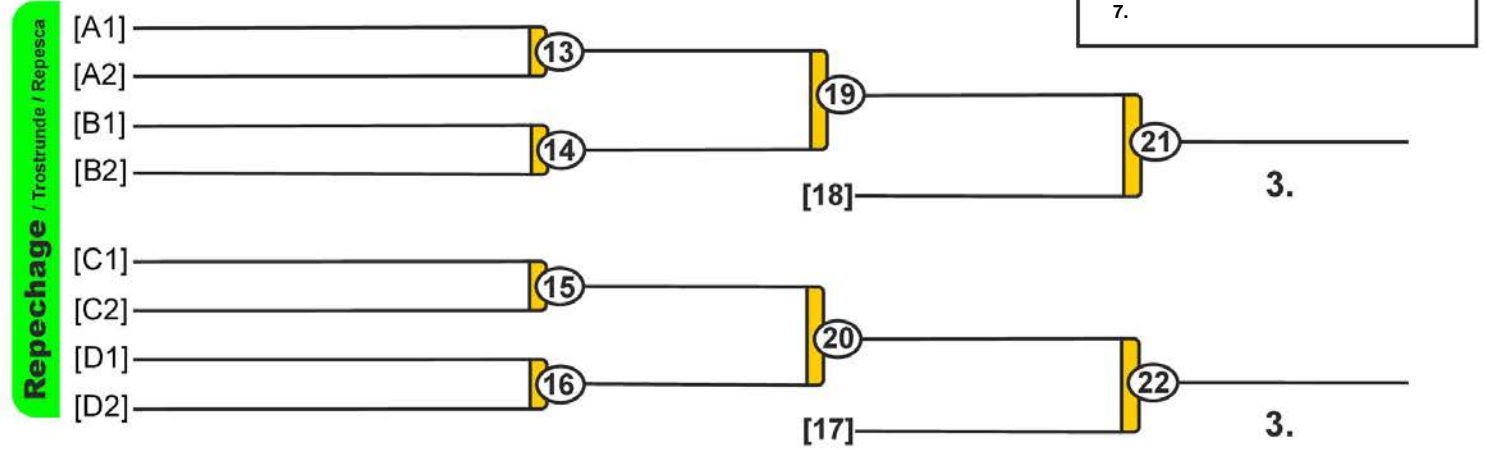

# Torneo Junior Villa Aviles 2016

Aviles (AST), 22 Oct 2016

## -57 kg

15 Judoka

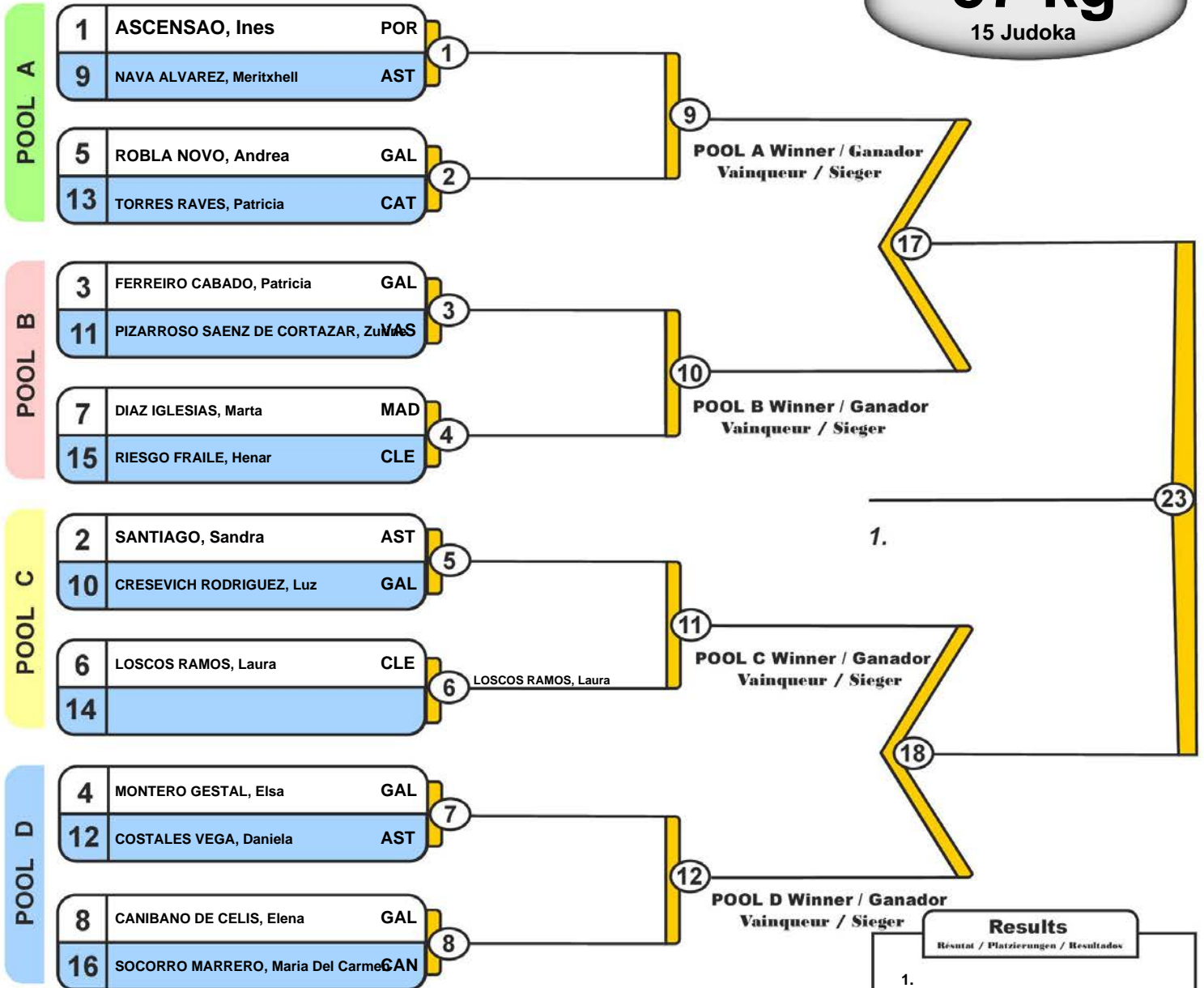

1.

18

Results	
Resultat / Platzierungen / Resultados	
1.	
2.	
3.	
3.	
5.	
5.	
7.	
7.	

### Trostrunde / Repechage / Ronda de consolación

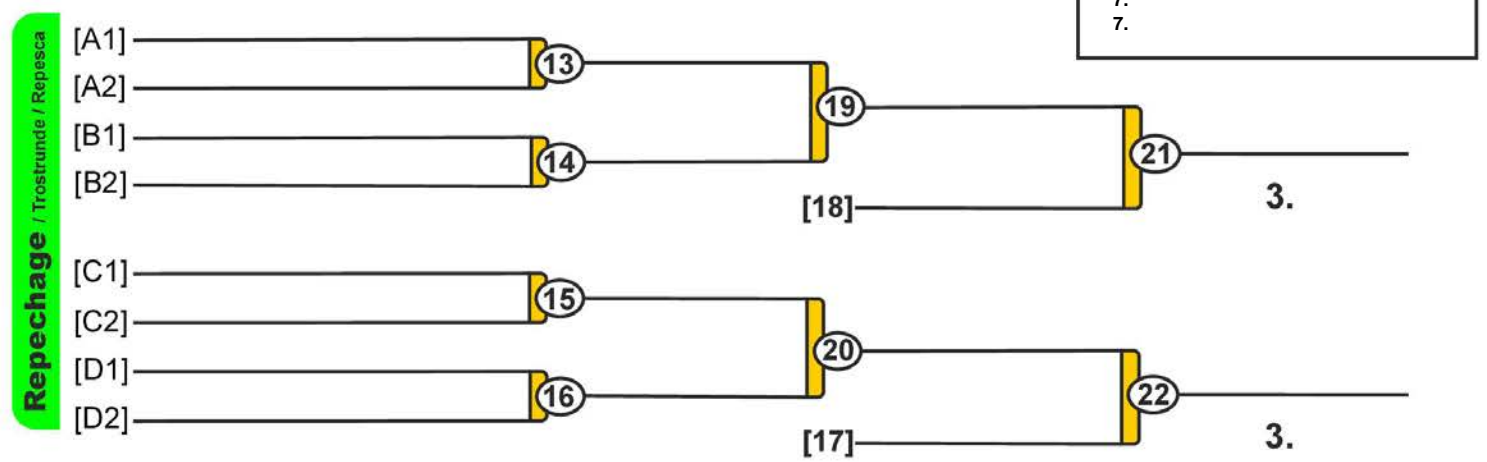



# Torneo Junior Villa Aviles 2016

Aviles (AST), 22 Oct 2016

## -63 kg

7 Judoka

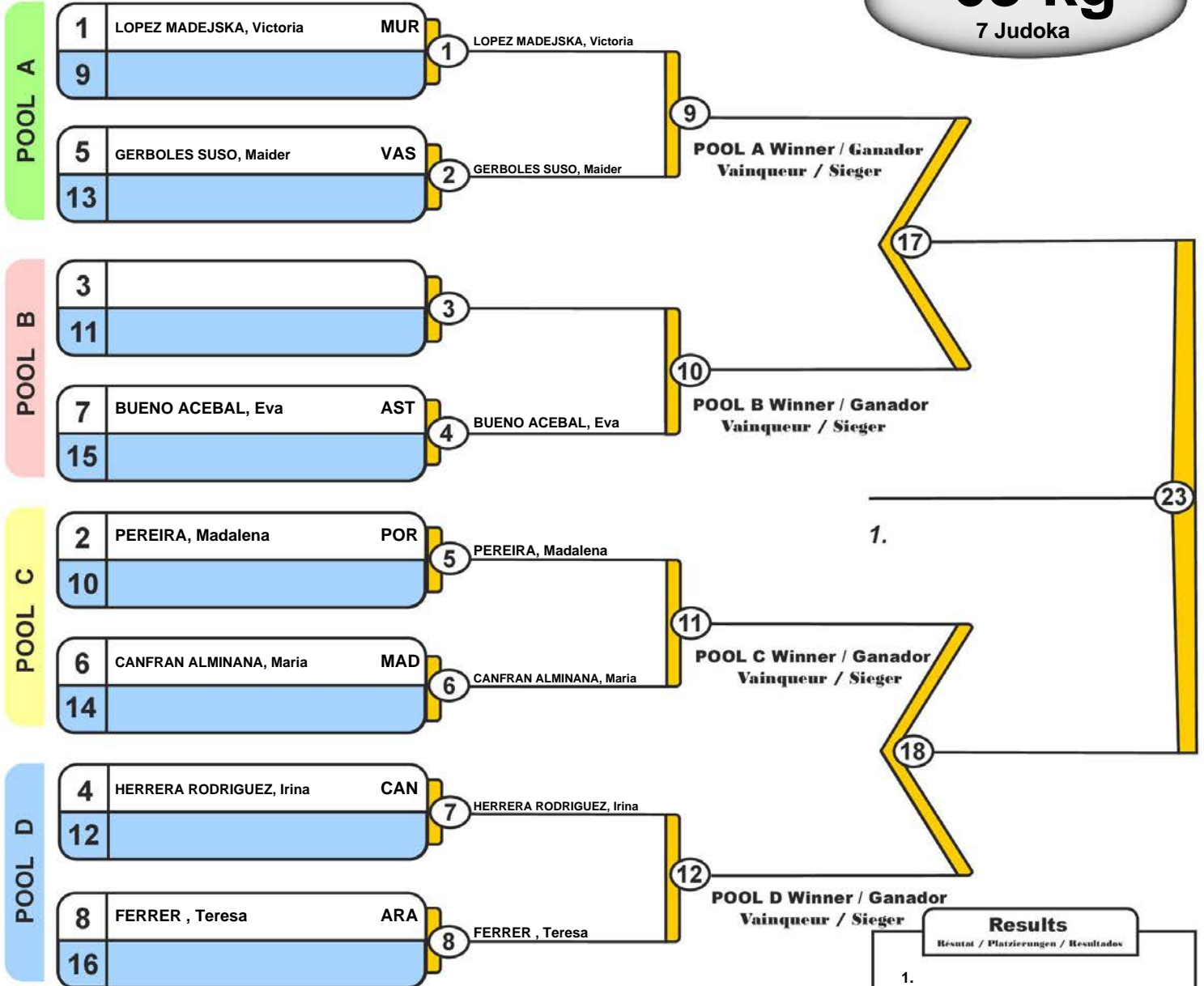

**Trostrunde / Repechage / Ronda de consolación**

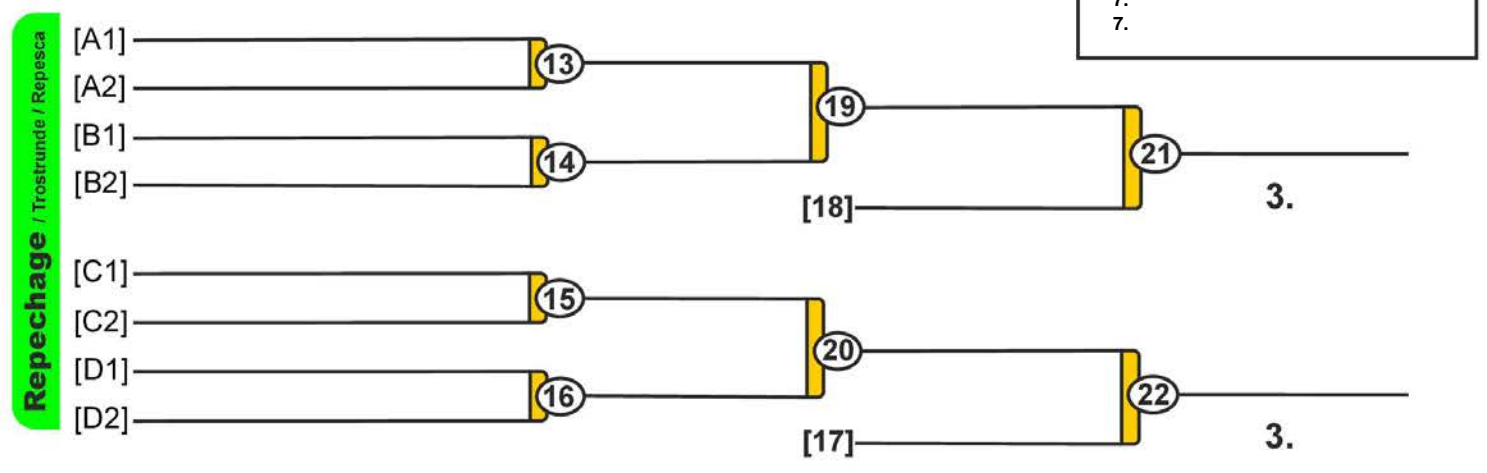

Results	
Resultat / Platzierungen / Resultados	
1.	
2.	
3.	
3.	
5.	
7.	
7.	

# Torneo Junior Villa Aviles 2016

Aviles (AST), 22 Oct 2016

## +63 kg

16 Judoka

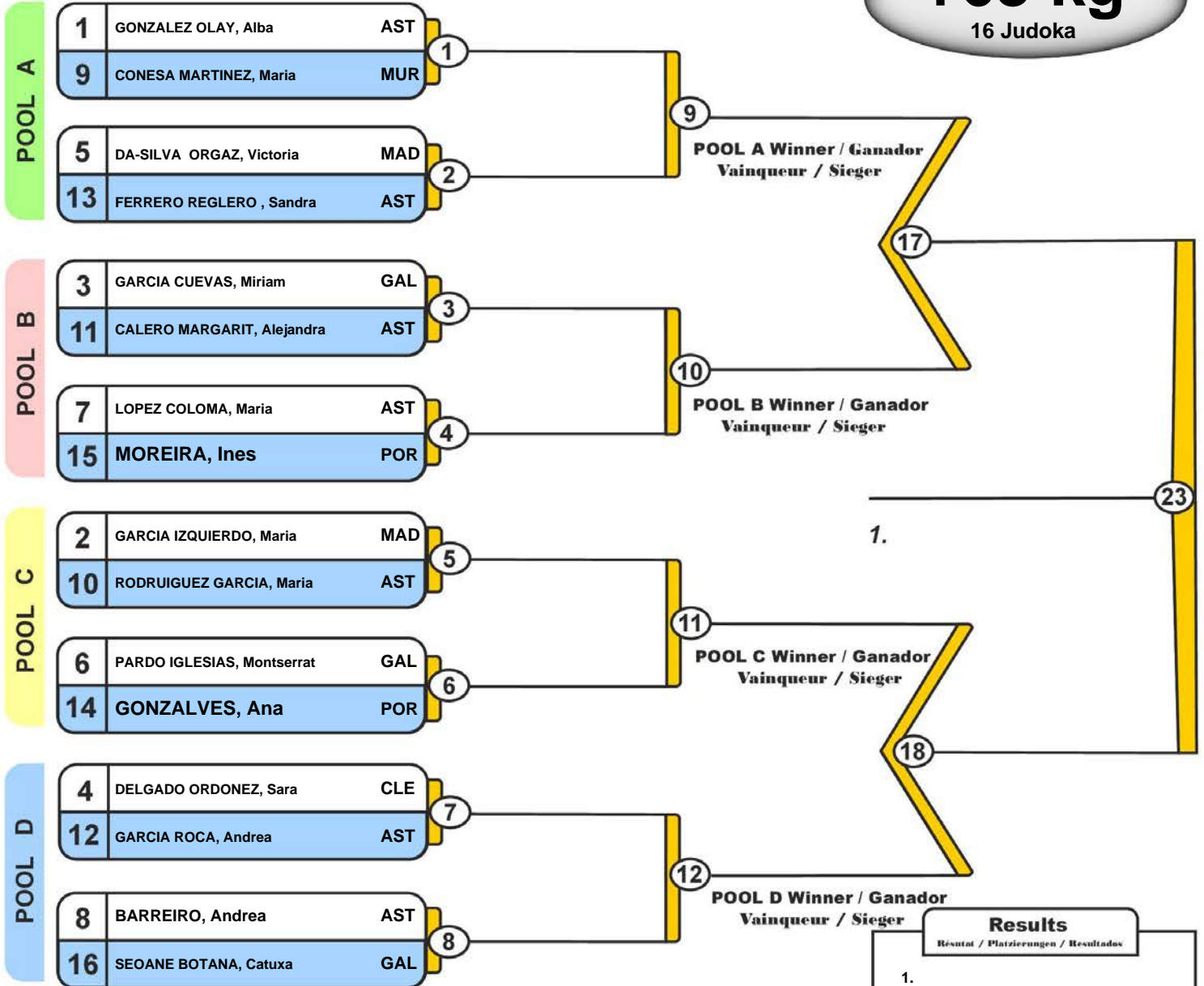

**Trostrunde / Repechage / Ronda de consolación**

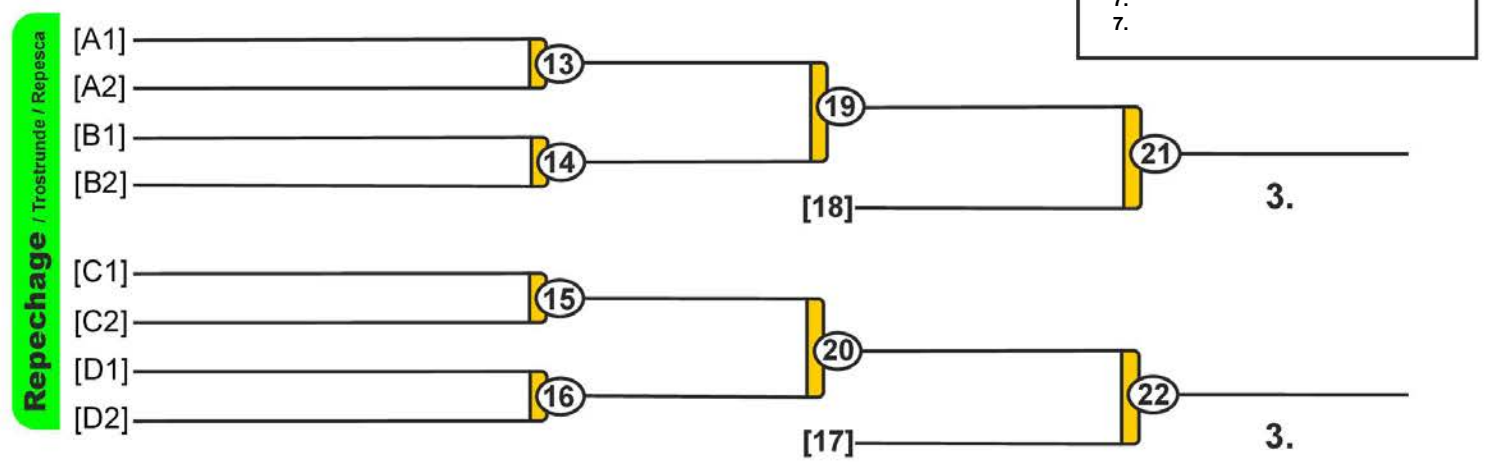

Results	
Resultat / Platzierungen / Resultados	
1.	
2.	
3.	
3.	
5.	
7.	
7.	